



**PEMERINTAH KOTA SEMARANG
DINAS PEKERJAAN UMUM**

JL. MADUKORO RAYA NO. 7, TELP. (024) 76433969, FAX. (024) 76433969 KOTA SEMARANG

**FORM INVENTARISASI JEMBATAN
Ruas Jalan
SAPUTAN**

NO JEMBATAN : KT.33.074.10.0103.001
NAMA JEMBATAN : SAPUTAN
TAHUN ANGGARAN : 2024



PEMERINTAH KOTA SEMARANG
DINAS PEKERJAAN UMUM

JL. MADUKORO RAYA NO. 7, TELP. (024) 76433969, FAX. (024) 76433969 KOTA SEMARANG

SISTEM
MANAJEMEN
JEMBATAN



LAPORAN PEMERIKSAAN INVENTARISASI JEMBATAN

No. Jembatan Ruas Jalan Kabupaten dan Kota

| | | | | | | | | | | | | | | | |
|----|---|---|---|---|---|---|---|---|---|---|---|---|---|---|--|
| KT | 3 | 3 | 0 | 7 | 4 | 1 | 0 | 0 | 1 | 0 | 3 | 0 | 0 | 1 | |
|----|---|---|---|---|---|---|---|---|---|---|---|---|---|---|--|

| | | | | | | |
|-------------------------------|-------------------------------------|---------------|-------------------------------|---------|--------------------------------------|------|
| Nama Jembatan | SAPUTAN | | | | Propinsi / Kabupaten / Kota Semarang | |
| Lokasi Jembatan | Koordinat Awal : -7.016706 LS | 110.448792 BT | Dari (Kota Asal/Km.No1) : SMG | | Km. (Jarak dari kota asal) : 0+020 | |
| | Koordinat Akhir : -7.016706 LS | 110.448792 BT | | | | |
| Tanggal Pemeriksaan 16/5/2024 | Nama Pemeriksa / NIP GENDUT SUMANTO | | | | Tahun Pembangunan 2007 | |
| Nilai Lalu - Lintas : | 0,208824 | LHR : | 879 | Tahun : | | 2019 |

INFORMASI PEMBANGUNAN JEMBATAN

| | | |
|--|---|------------------|
| 1 Tanggal / Bulan / Tahun pembangunan jembatan / pengoperasian pertama kali | : | 2007 |
| 2 Tanggal / Bulan / Tahun pelebaran/rehabilitasi/perkuatan jembatan / pengoperasian pertama kali | : | - |
| 3 Tanggal / Bulan / Tahun serah terima aset | : | - |
| 4 Penanggung jawab pembangunan (Satker/PPK) | : | - |
| 5 Penanggung jawab pelebaran/rehabilitasi/perkuatan jembatan (Satker/PPK) | : | - |
| 6 Biaya perencanaan | : | - |
| 7 Biaya pembangunan | : | RP. 219,706,000 |
| 8 Biaya pelebaran/rehabilitasi/perkuatan jembatan | : | - |
| 9 Biaya pengujian | : | - |
| 10 Nilai aset serah terima | : | - |
| 11 Nama konsultan perencana pembangunan | : | - |
| 12 Nama <i>Independent Proof Checker</i> (IPC) | : | - |
| 13 Nama konsultan perencana pelebaran/rehabilitasi/perkuatan jembatan | : | - |
| 14 Nama kontraktor pelaksana pembangunan | : | - |
| 15 Nama kontraktor pelaksana pelebaran/rehabilitasi/perkuatan jembatan | : | - |
| 16 Nama subkontraktor spesialis | : | - |
| 17 Nama konsultan pengawas pembangunan | : | - |
| 18 Nama konsultan pengawas pelebaran/rehabilitasi/perkuatan jembatan | : | - |
| 19 Nama konsultan pengujian | : | - |
| | | Tersedia / Tidak |
| 20 Laporan pembangunan/pelebaran/rehabilitasi/perkuatan jembatan | : | Tidak |
| 21 <i>As-built-drawing</i> atau denah jembatan | : | Tidak |
| | | File |
| | | - |
| | | - |

| | |
|--|----------------------|
| Hanya untuk keperluan kantor | |
| Tanggal memasukkan Data Pemeriksaan Inventarisasi 23/5/2024 | Oleh : WAHYU DWIS |



PEMERINTAH KOTA SEMARANG
DINAS PEKERJAAN UMUM

JL. MADUKORO RAYA NO. 7, TELP. (024) 76433969, FAX. (024) 76433969 KOTA SEMARANG

INFORMASI KAPASITAS MUATAN

| | | | |
|--|---|-------|-------|
| 1 Batasan muatan sumbu terberat MST | : | 6 | ton |
| 2 Beban maksimum yang pernah di atas jembatan | : | 6 | ton |
| 3 Jenis kendaraan berat yang umum lewat di atas jembatan | : | TRUCK | |
| 4 Tindakan darurat yang sedang/pernah dilakukan di atas jembatan | : | C | |
| a. Pembatasan beban | | | |
| b. Penyokongan/Sangga | | | |
| c. Penutupan parsial/Sebagian | | | |
| d. Penutupan penuh | | | |
| e. Jalan Memutar/ <i>detour</i> | | | |
| f. Jembatan Sementara | | | |
| 5 Apakah tersedia jalan memutar/ <i>detour</i> jika jembatan ditutup | | Ya | tidak |
| 6 Panjang jarak tambahan yang harus ditempuh dengan jalan memutar | | 500 | m |

INFORMASI KAPASITAS LALU LINTAS

| | | | |
|--|---|------|---|
| 1 Lalu - lintas harian rata-rata tahunan (LHR) AADT | : | 879 | |
| 2 Nilai Lalu - Lintas (Perbandingan lebar jalur lalu-lintas yang tersedia di atas jembatan dengan lebar perkerasan sebelum masuk ke dalam jembatan | | | |
| Longgar kendaraan bebas melintas di atas jembatan | | 0 | |
| Cukup lebar kendaraan melaju perlahan di atas jembatan | | 3 | |
| Sempit kendaraan harus antri atau berhenti | | 5 | |
| 3 Lebar kendaraan maksimum (<i>ODOL/Over-dimension overload vehicle</i>) | : | 2.50 | m |

INFORMASI BATASAN PERLINTASAN DAN LINGKUNGAN

| | | | |
|---|---|------|---|
| 1 Tinggi muka air banjir terhadap bagian atas lantai jembatan | : | 4.00 | m |
| 2 Tinggi muka air banjir terhadap elevasi perletakan jembatan | : | - | m |
| 3 Tinggi muka air banjir terhadap elevasi terbawah bangunan atas jembatan | : | 3.00 | m |
| 4 Kedalaman gerusan di sekitar pilar | : | - | m |
| 5 Kedalaman gerusan di sekitar kepala jembatan | : | - | m |
| 6 Kedalaman gerusan di sekitar tanah timbunan atau bangunan pengaman lainnya | : | - | m |
| 7 Tinggi bebas perlintasan <i>overpass</i> jalan | : | - | m |
| 8 Tinggi bebas perlintasan kereta api | : | - | m |
| 9 Tinggi bagian tertinggi dari kapal laut dan/atau angkutannya terhadap elevasi terbawah bangunan atas jembatan | : | - | m |
| 10 Lebar alur pelayaran untuk dibandingkan dengan kapal laut | : | - | m |
| 11 Tinggi pylon dengan batasan lintasan pesawat udara dekat bandara | : | - | m |



PEMERINTAH KOTA SEMARANG
DINAS PEKERJAAN UMUM

JL. MADUKORO RAYA NO. 7, TELP. (024) 76433969, FAX. (024) 76433969 KOTA SEMARANG

KODE-KODE PEMERIKSAAN INVENTARISASI JEMBATAN

| Tipe Lintasan | | JN (jalan) | SL (sungai lurus) | SM (sungai meander) | SB (sungai berjaln) | S/T (selat atau teluk) | KA (Kereta Api) | L (lain-lain) | | | | | | |
|-----------------------------|---|----------------|-----------------------------------|---------------------|-------------------------------|--|------------------------------------|---|------------------------------------|--------------|--------------------------------|---------------------------|------------|---|
| A. TBA (Tipe Bangunan Atas) | | B. BHN (Bahan) | | | C1. SBA (Sifat Bangunan Atas) | | C2. Keterangan Detail | | D. TF (Tipe Fondasi) | | E. KJP (Kepala Jembatan/Pilar) | | | |
| B | gorong-gorong persegi | K | Kayu | P | Permanen | A | Australia | CA | Cakar Ayam | A | Cap (Kepala tiang) | | | |
| Y | gorong-gorong pipa | S | Pasangan bata | S | Semi Permanen | T | Australia (Sementara) | LS | Langsung | B | Dinding penuh | | | |
| A | gorong-gorong pelengkung | M | Pasangan batu | W | Darurat | B | Belanda (tipe baru) | TP | Tiang Pancang | K | Kepala jembatan khusus | | | |
| T | gantung | G | Bronjong dan sejenisnya | X | Tidak ada struktur | D | Belanda (tipe lama) | PB | Tiang Bor | Pilar | | | | |
| C | Jembatan Gantungan / Beruji Kabel (Cable Stayed) | H | Pasangan batu kosong | M | Bergerak | I | Indonesia | TU | Tiang Ulir | | | | | |
| G | gelagar | D | Beton tak bertulang | F | Apung | J | Jepang | SU | Sumuran | PILON | | | | |
| M | gelagar komposit | T | Beton bertulang | | | R | Austria | LL | Lain-lain | | | | | |
| O | Gelagar Boks | P | Beton pratekan | | | E | Spanyol | A Tipe A D Tipe Diamond H Tipe H I Tipe Tunggal / I Y Tipe Y V Tipe V terbuka W Tipe Double I | | C | Cap (kepala tiang) | | | |
| Q | Gelagar tipe U | B | Baja | | | U | Callender Hamilton (UK/Inggris) | | | P | Dinding penuh | S | Satu kolom | |
| L | balok pelengkung | U | Pelat baja gelombang | | | W | Acrow/Bailey | D | Dua kolom | D | Dua kolom | | | |
| E | pelengkung | Y | Komposit Baja - beton | | | Catatan : <i>Asal produksi jembatan, apabila diketahui pasti, dari pemeriksaan detail dapat dituliskan atau diganti dengan sifat apabila tidak pasti</i> | | H | Tipe H | L | Lain-lain | | | |
| D | Flat Slab | J | Aluminium | | | | | I | Tipe Tunggal / I | V | Tipe V | V | Tipe V | |
| V | Voided Slab | E | Neoprene / karet | | | | | Tiang Sandaran | | | TB | tiang beton sandaran baja | | |
| R | rangka | F | Teflon | | | | | | | | BB | tiang baja sandaran baja | DB | dinding bagian bawah + sandaran baja |
| P | Pelat | V | PVC | | | | | DD | Sandaran/Median beton bertulang | KK | tiang kayu sandaran kayu | | | |
| F | ferry | N | geotextile | | | | | | | | | | | |
| K | lintasan kereta api | O | Tanah biasa/lempung atau timbunan | | | | | | | | | | | |
| W | lintasan basah | A | Aspal | | | | | | | | | | | |
| U | lain-lain | R | kerikil/pasir | | | | | | | | | | | |
| | | W | Macadam | | | | | | | | | | | |
| | | X | Bahan asli | | | | | | | | | | | |
| | | L | Lain-lain | | | | | | | | | | | |



PEMERINTAH KOTA SEMARANG
DINAS PEKERJAAN UMUM

JL. MADUKORO RAYA NO. 7, TELP. (024) 76433969, FAX. (024) 76433969 KOTA SEMARANG

NO. JEMBATAN :

| | | | | | | | | | | | | | | | |
|----|---|---|---|---|---|---|---|---|---|---|---|---|---|---|--|
| KT | 3 | 3 | 0 | 7 | 4 | 1 | 0 | 0 | 1 | 0 | 3 | 0 | 0 | 1 | |
|----|---|---|---|---|---|---|---|---|---|---|---|---|---|---|--|

NAMA JEMBATAN :

SAPUTAN-----

POTONGAN MEMANJANG

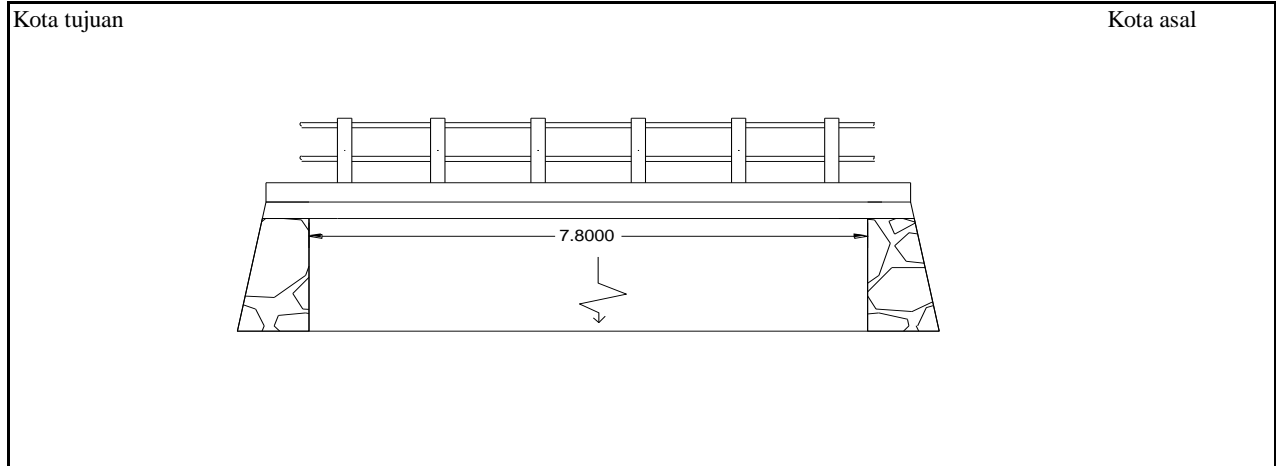

TAMPAK ATAS

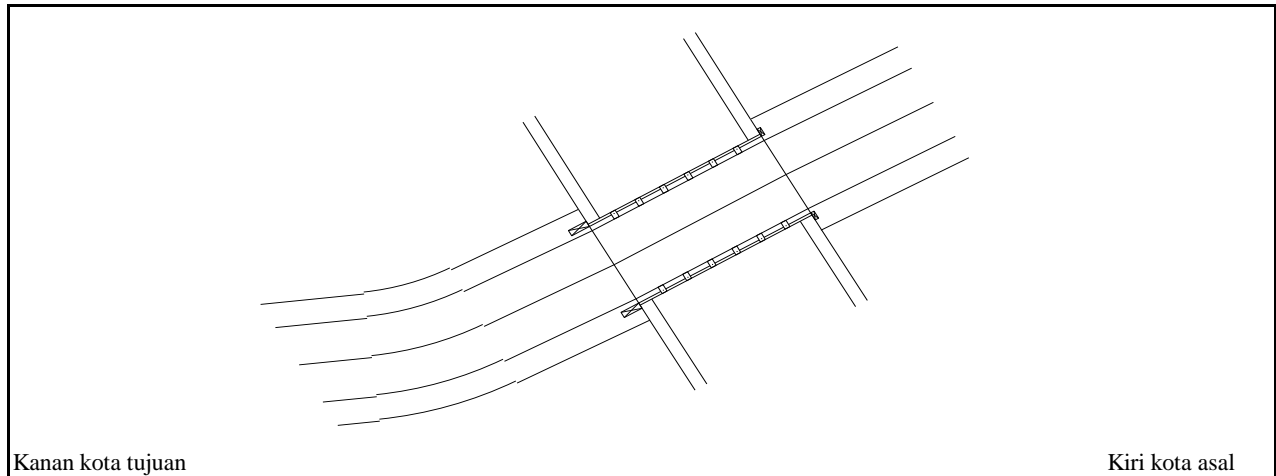

SITUASI

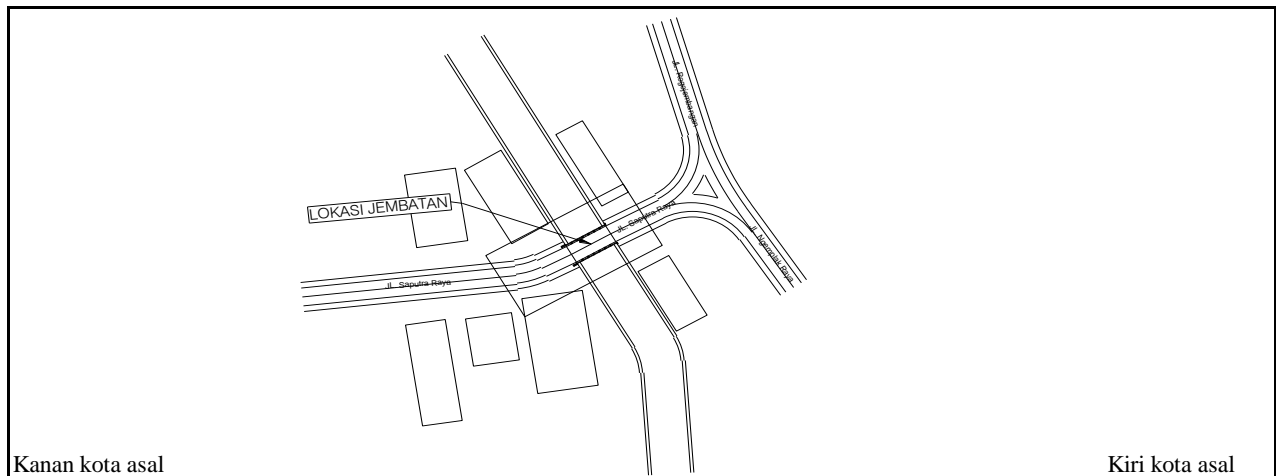



PEMERINTAH KOTA SEMARANG
DINAS PEKERJAAN UMUM

JL. MADUKORO RAYA NO. 7, TELP. (024) 76433969, FAX. (024) 76433969 KOTA SEMARANG



TAMPAK MEMANJANG



TAMPAK MEMANJANG



TAMPAK MELINTANG



TAMPAK MELINTANG

| NOMOR JEMBATAN | NAMA JEMBATAN | LOKASI (Km) | PANJANG (M) |
|-----------------------|----------------------|--------------------|--------------------|
| KT.33.074.10.0103.001 | SAPUTAN | 0+020 | 7.80 |



**PEMERINTAH KOTA SEMARANG
DINAS PEKERJAAN UMUM**

JL. MADUKORO RAYA NO. 7, TELP. (024) 76433969, FAX. (024) 76433969 KOTA SEMARANG



KONDISI BANGUNAN BAWAH



SANDRAN KEROPOS DAN PECAH



KONDISI ALRAN SUNGAI



KONDISI LAPISAN PERMUKAAN LANTAI

| NOMOR JEMBATAN | NAMA JEMBATAN | LOKASI (Km) | PANJANG (M) |
|-----------------------|----------------------|--------------------|--------------------|
| KT.33.074.10.0103.001 | SAPUTAN | 0+020 | 7.80 |



**PEMERINTAH KOTA SEMARANG
DINAS PEKERJAAN UMUM**

JL. MADUKORO RAYA NO. 7, TELP. (024) 76433969, FAX. (024) 76433969 KOTA SEMARANG

**FORM DETAIL JEMBATAN
Ruas Jalan
SAPUTAN**

NO JEMBATAN : KT.33.074.10.0103.001
NAMA JEMBATAN : SAPUTAN
TAHUN ANGGARAN : 2024



**PEMERINTAH KOTA SEMARANG
DINAS PEKERJAAN UMUM**

JL. MADUKORO RAYA NO. 7, TELP. (024) 76433969, FAX. (024) 76433969 KOTA SEMARANG

SISTEM
MANAJEMEN
JEMBATAN



LAPORAN PEMERIKSAAN DETAIL JEMBATAN

No. Jembatan Ruas Jalan Kabupaten dan Kota

| | | | | | | | | | | | | | | |
|----|---|---|---|---|---|---|---|---|---|---|---|---|---|---|
| KT | 3 | 3 | 0 | 7 | 4 | 1 | 0 | 0 | 1 | 0 | 3 | 0 | 0 | 1 |
|----|---|---|---|---|---|---|---|---|---|---|---|---|---|---|

| | | | | | | |
|----------------------------------|--|-----------|-----|--------------|--------------------------------------|------------------------------------|
| Nama Jembatan | SAPUTAN | | | | Propinsi / Kabupaten / Kota Semarang | |
| Lokasi Jembatan | Koordinat Awal : | -7.016706 | LS | 110.448792 | BT | Dari (Kota Asal/Km.No) : SMG |
| | Koordinat Akhir : | -7.016706 | LS | 110.448792 | BT | Km. (Jarak dari kota asal) : 0+020 |
| Tanggal Pemeriksaan 16/5/2024 | Nama Pemeriksa / NIP GENDUT SUMANTO | | | | Tahun Pembangunan 2007 | |
| Nilai Traffic : | 0,208824 | LHR : | 879 | Tahun : 2019 | | |

USULAN PEMERIKSAAN KHUSUS

| | | |
|--------------------------------------|----|-------|
| Apakah tindakan darurat disarankan ? | Ya | Tidak |
|--------------------------------------|----|-------|

Elemen elemen yang memerlukan Pemeriksaan Khusus

| Kode | Elemen Uraian | Lokasi | | | | Alasan untuk melakukan pemeriksaan khusus |
|------|------------------|--------|---|---|---|---|
| | | A/P/B | X | Y | Z | |
| | | | | | | |
| | | | | | | |
| | | | | | | |
| | | | | | | |
| | | | | | | |

TINDAKAN DARURAT

| | | |
|--------------------------------------|----|-------|
| Apakah tindakan darurat disarankan ? | Ya | Tidak |
|--------------------------------------|----|-------|

Elemen elemen yang memerlukan Tindakan Darurat

| Kode | Elemen Uraian | Lokasi | | | | Alasan untuk melakukan pemeriksaan khusus |
|------|------------------|--------|---|---|---|---|
| | | A/P/B | X | Y | Z | |
| | | | | | | |
| | | | | | | |
| | | | | | | |
| | | | | | | |
| | | | | | | |

Hanya untuk keperluan kantor

| | |
|--|----------------------|
| Tanggal memasukkan Data Pemeriksaan Inventarisasi 23/5/2024 | Oleh : WAHYU DWIS |
|--|----------------------|

| Elemen | | Elemen | | Elemen | | Kerusakan | | Lokasi | | | | | Level 5 | | | | | Level 4 | | | | | | |
|--------|--------------------------|--------|--|--------|--|-----------|------------------|--------|---|---|---|---|---------|---|---|---|----|---------|---|---|---|---|----|---|
| Kode | Uraian Level 2 (pilihan) | Kode | Uraian Level 3 (pilihan) | Kode | Uraian (pilihan) | Kode | Uraian (pilihan) | A/P/B | X | Y | Z | S | R | K | F | P | NK | S | R | K | F | P | NK | |
| | | | | 4.443 | Sambungan Balok Pelengkung | | | | | | | | | | | | | | | | | | | |
| | | | | 4.444 | Balok Pelengkung Rangka Baja | | | | | | | | | | | | | | | | | | | |
| | | | | 4.445 | Pencantuna Rangka Baja | | | | | | | | | | | | | | | | | | | |
| | | | | 4.446 | Perkuatan Balok Pelengkung | | | | | | | | | | | | | | | | | | | |
| | | | | 4.447 | Drainase Balok Pelengkung | | | | | | | | | | | | | | | | | | | |
| | | 3.450 | Rangka | 4.451 | Rangka Jembatan Panel | | | | | | | | | | | | | | | | | | | |
| | | | | 4.451 | Rangka Jembatan Panel | | | | | | | | | | | | | | | | | | | |
| | | | | 4.452 | Sambungan Rangka Jembatan Panel | | | | | | | | | | | | | | | | | | | |
| | | | | 4.453 | Struktur Rangka Jembatan Panel | | | | | | | | | | | | | | | | | | | |
| | | | | 4.454 | Pemaku Rangka | | | | | | | | | | | | | | | | | | | |
| | | | | 4.455 | Sambungan Rangka Baja | | | | | | | | | | | | | | | | | | | |
| | | | | 4.456 | Perkuatan Jembatan Rangka | | | | | | | | | | | | | | | | | | | |
| | | | | 4.457 | Drainase Rangka | | | | | | | | | | | | | | | | | | | |
| | | 3.460 | Jembatan - Beruji - Kabel (Cable-stayed) | 4.461 | Sistem Kabel Jembatan-Beruji-Kabel | | | | | | | | | | | | | | | | | | | |
| | | | | 4.462 | Sistem Penahan Kabel Jembatan-beruji-kabel | | | | | | | | | | | | | | | | | | | |
| | | | | 4.463 | Gelagar Melintang Jembatan Beruji Kabel (Cable-stayed) | | | | | | | | | | | | | | | | | | | |
| | | | | 4.464 | Perkuatan Jembatan Beruji Kabel (Cable stayed) | | | | | | | | | | | | | | | | | | | |
| | | 3.470 | Jembatan Gantung | 4.471 | Sistem Kabel Jembatan Gantung | | | | | | | | | | | | | | | | | | | |
| | | | | 4.472 | Batang Penggantung Jembatan Gantung | | | | | | | | | | | | | | | | | | | |
| | | | | 4.473 | Pemaku Jembatan Gantung | | | | | | | | | | | | | | | | | | | |
| | | | | 4.474 | Sistem penahan Kabel Jembatan Gantung | | | | | | | | | | | | | | | | | | | |
| | | | | 4.475 | Perkuatan Jembatan Gantung | | | | | | | | | | | | | | | | | | | |
| | | | | 4.486 | saedl pylon | | | | | | | | | | | | | | | | | | | |
| | | | | 4.487 | balok melintang | | | | | | | | | | | | | | | | | | | |
| | | | | 4.488 | ikatan angin bawah | | | | | | | | | | | | | | | | | | | |
| | | | | 4.489 | gantung/ sambungan | | | | | | | | | | | | | | | | | | | |
| | | 3.480 | Pilon | 4.481 | Struktur Pilon | | | | | | | | | | | | | | | | | | | |
| | | | | 4.482 | Penahan Kabel di Pilon | | | | | | | | | | | | | | | | | | | |
| | | | | 4.483 | Pilon Baja | | | | | | | | | | | | | | | | | | | |
| | | | | 4.484 | Sambungan Pilon Baja | | | | | | | | | | | | | | | | | | | |
| | | | | 4.485 | Perkuatan Pilon | | | | | | | | | | | | | | | | | | | |
| | | | | 4.486 | Drainase pilon | | | | | | | | | | | | | | | | | | | |
| | | 3.490 | Gelagar Boks | 4.491 | Struktur Gelagar Boks | | | | | | | | | | | | | | | | | | | |
| | | | | 4.492 | Pemaku gelagar boks | | | | | | | | | | | | | | | | | | | |
| | | | | 4.493 | Sambungan Gelagar Boks | | | | | | | | | | | | | | | | | | | |
| | | | | 4.494 | Prategang Eksternal dalam gelagar boks | | | | | | | | | | | | | | | | | | | |
| | | | | 4.495 | Perkuatan gelagar boks | | | | | | | | | | | | | | | | | | | |
| | | | | 4.496 | Drainase Gelagar Boks | | | | | | | | | | | | | | | | | | | |
| | | 3.500 | Sistem Lantai | 4.511 | Struktur Lantai | | | | | | | | | | | | | | | | | | | |
| | | | | 4.512 | Pemangga Sistem Lantai | | | | | | | | | | | | | | | | | | | |
| | | | | 4.513 | Trottoar dan kerb | | | | | | | | | | | | | | | | | | | |
| | | | | 4.514 | Lapis Permukaan Sistem Lantai | | | | | | | 0 | 0 | 0 | 0 | 0 | 0 | 0 | 0 | 0 | 0 | 0 | 0 | 0 |
| | | | | 4.515 | Perkuatan Sistem Lantai | | | | | | | | | | | | | | | | | | | |
| | | | | 4.516 | Link Slab | | | | | | | | | | | | | | | | | | | |
| | | | | 4.517 | Drainase Lantai | | | | | | | | | | | | | | | | | | | |
| | | 3.600 | Sambungan/Siar Muai | 4.601 | Sambungan/Siar Muai Baja (tipe geragai) | | | | | | | | | | | | | | | | | | | |
| | | | | 4.602 | Sambungan/Siar Muai Baja Siku Profil Terbuka | | | | | | | | | | | | | | | | | | | |
| | | 3.610 | Landasan/Perletakan | 4.611 | Landasan | | | | | | | | | | | | | | | | | | | |
| | | | | 4.612 | Peredam Pasif/Damping Struktur | | | | | | | | | | | | | | | | | | | |
| | | | | 4.613 | Peredam Aktif Struktur | | | | | | | | | | | | | | | | | | | |
| | | | | 4.614 | Pendukung landasan | | | | | | | | | | | | | | | | | | | |
| | | | | 4.615 | Penahan pergerakan landasan | | | | | | | | | | | | | | | | | | | |
| | | | | 4.616 | Isolasi Perletakan Lainnya | | | | | | | | | | | | | | | | | | | |
| | | 3.620 | Pengaman Pengguna Jalan | 4.621 | Struktur Sandaran Kaalline | | | | | | | 0 | 1 | 0 | 0 | 0 | 1 | 0 | 1 | 0 | 0 | 0 | 0 | 1 |
| | | | | 4.622 | Struktur tembok | | | | | | | | | | | | | | | | | | | |
| | | | | 4.623 | Pembatas lainnya | | | | | | | | | | | | | | | | | | | |
| | | 3.630 | Perlengkapan Aerodinamik Jembatan | 4.631 | Perlengkapan Aerodinamik Banaan Atas | | | | | | | | | | | | | | | | | | | |
| | | | | 4.632 | Perlengkapan Aerodinamik Permukaan Kabel Jembatan | | | | | | | | | | | | | | | | | | | |
| | | | | 4.633 | Wind Barrier | | | | | | | | | | | | | | | | | | | |
| 2.700 | Perlengkapan | 3.710 | Perlengkapan Umum | 4.711 | Perangkat Pengendali Lalu Lintas | | | | | | | | | | | | | | | | | | | |
| | | | | 4.712 | Penanda Jembatan | | | | | | | | | | | | | | | | | | | |
| | | | | 4.713 | Penujangan Perlengkapan | | | | | | | | | | | | | | | | | | | |
| | | | | 4.714 | Struktur Penutup Jembatan | | | | | | | | | | | | | | | | | | | |
| | | | | 4.715 | Pendukung sandaran / median | | | | | | | | | | | | | | | | | | | |
| | | | | 4.721 | Sistem penerangan | | | | | | | | | | | | | | | | | | | |
| | | 3.720 | Penerangan | 4.721 | Sistem penerangan | | | | | | | | | | | | | | | | | | | |

| LEVEL 3 | | Nilai Kondisi | | | | | |
|---------|--------|---------------|---|---|---|---|----|
| Kode | Elemen | S | R | K | F | P | NK |

| Elemen | | Elemen | | Elemen | | Kerusakan | | Lokasi | | | | | Level 5 | | | | | Level 4 | | | | | | |
|--------|--------------------------|--------|---|--------|---|-----------|------------------|--------|---|---|---|---|---------|---|---|---|----|---------|---|---|---|---|----|---|
| Kode | Uraian Level 2 (pilihan) | Kode | Uraian Level 3 (pilihan) | Kode | Uraian (pilihan) | Kode | Uraian (pilihan) | A/P/B | X | Y | Z | S | R | K | F | P | NK | S | R | K | F | P | NK | |
| | | | | 4,722 | Struktur Tiang Penemuan | | | | | | | | | | | | | | | | | | | |
| | | | | 4,723 | Penujangan Penerangan | | | | | | | | | | | | | | | | | | | |
| | | 3,730 | Utilitas | 4,731 | Utilitas Kabel Listrik | | | | | | | | | | | | | | | | | | | |
| | | | | 4,732 | Utilitas Pipa Air Minum | | | 0 | 0 | 0 | 0 | 0 | 0 | 0 | 0 | 0 | 0 | 0 | 0 | 0 | 0 | 0 | 0 | 0 |
| | | | | 4,733 | Utilitas Kabel Telekomunikasi | | | | | | | | | | | | | | | | | | | |
| | | | | 7,734 | Utilitas Pipa Air Kotor | | | | | | | | | | | | | | | | | | | |
| | | | | 4,735 | Utilitas Pipa Pembawa Bahan Energi lainnya | | | | | | | | | | | | | | | | | | | |
| | | | | 7,736 | Sambungan utilitas | | | | | | | | | | | | | | | | | | | |
| | | | | 4,737 | Dudukan utilitas | | | | | | | | | | | | | | | | | | | |
| | | 3,740 | Pengaman Struktur dan Jalan Lingkungan | 4,741 | Perangkat Pengendali Kelembaban | | | | | | | | | | | | | | | | | | | |
| | | | | 4,742 | Perangkat Penangkal Petir | | | | | | | | | | | | | | | | | | | |
| | | | | 4,743 | Perangkat Perlindungan Korosi dan Biota Laut | | | | | | | | | | | | | | | | | | | |
| | | | | 4,744 | Labang Ventilasi | | | | | | | | | | | | | | | | | | | |
| | | | | 4,745 | Penutup Lubang Ventilasi | | | | | | | | | | | | | | | | | | | |
| | | 3,750 | SMKS (Sistem Monitoring Kesehatan Jembatan) | 4,751 | Sensor Struktur | | | | | | | | | | | | | | | | | | | |
| | | | | 4,752 | Perangkat Pengukur Beban Kendaraan | | | | | | | | | | | | | | | | | | | |
| | | | | 4,753 | Sensor pengukur Beban Kendaraan | | | | | | | | | | | | | | | | | | | |
| | | | | 4,754 | Pendukung lainnya | | | | | | | | | | | | | | | | | | | |
| | | 3,760 | Perlengkapan Jembatan Gerak / moveable bridge | 4,755 | Perangkat Penyalur Data | | | | | | | | | | | | | | | | | | | |
| | | | | 4,761 | Sistem peneraer fungsional | | | | | | | | | | | | | | | | | | | |
| | | | | 4,762 | Sistem Elektrik | | | | | | | | | | | | | | | | | | | |
| | | | | 4,763 | Sistem Hidrolik | | | | | | | | | | | | | | | | | | | |
| | | | | 4,764 | Sistem Mekanis | | | | | | | | | | | | | | | | | | | |
| | | 3,770 | Fasilitas Pemeriksaan Tetap | 4,771 | Tangga / Platform Pemeriksaan | | | | | | | | | | | | | | | | | | | |
| | | | | 4,772 | Lubang Masuk (gelagar, kolom) | | | | | | | | | | | | | | | | | | | |
| | | | | 4,773 | Traveler | | | | | | | | | | | | | | | | | | | |
| 2.800 | gorong - gorong | 3,810 | Tanah di dalam struktur Gorong - gorong | 4,811 | Tanah timbunan di atas gorong - gorong | | | | | | | | | | | | | | | | | | | |
| | | | | 4,812 | Tanah dasar di bawah struktur gorong - gorong | | | | | | | | | | | | | | | | | | | |
| | | 3,820 | Gorong - gorong Persegi Boks | 4,821 | Dinding Tegak | | | | | | | | | | | | | | | | | | | |
| | | | | 4,822 | Pelat Bawah | | | | | | | | | | | | | | | | | | | |
| | | | | 4,823 | Pelat Atas | | | | | | | | | | | | | | | | | | | |
| | | | | 4,824 | Drainase Gorong - gorong Persegi Boks | | | | | | | | | | | | | | | | | | | |
| | | 3,830 | Gorong - gorong Pipa | 4,831 | Dinding penahan tanah timbunan | | | | | | | | | | | | | | | | | | | |
| | | | | 4,832 | Drainase Gorong - gorong Pipa | | | | | | | | | | | | | | | | | | | |
| | | | | 4,841 | Pelat Baja Gelombang | | | | | | | | | | | | | | | | | | | |
| | | | | 4,842 | Sambungan / Baut rekat | | | | | | | | | | | | | | | | | | | |
| | | | | 4,843 | Fondasi / Pelat Beton | | | | | | | | | | | | | | | | | | | |
| | | | | 4,844 | Dudukan Pelengkung Baja Gelombang | | | | | | | | | | | | | | | | | | | |
| | | | | 4,844 | Drainase Gorong gorong Pelengkung Baja Berrelombang | | | | | | | | | | | | | | | | | | | |
| | | 3,850 | Struktur Pendukung Gorong - gorong | 4,851 | Tembok Savan | | | | | | | | | | | | | | | | | | | |
| | | | | 4,852 | Tembok Kepala (Head wall) Gorong-gorong | | | | | | | | | | | | | | | | | | | |
| | | | | 4,853 | Tembok Bawah (Drop wall) Gorong-gorong | | | | | | | | | | | | | | | | | | | |
| | | | | 4,854 | Apron | | | | | | | | | | | | | | | | | | | |
| | | 3,860 | Perkuatan Gorong - gorong | 4,861 | Perkuatan dengan Lapisan Beton Tambahan | | | | | | | | | | | | | | | | | | | |
| | | | | 4,862 | Perkuatan dengan FRP | | | | | | | | | | | | | | | | | | | |
| | | | | 4,863 | Perkuatan dengan Lapisan Baja Tambahan | | | | | | | | | | | | | | | | | | | |
| 2.900 | Struktur Lintasan B | 3,910 | Lintasan dengan Perkerasan | | | | | | | | | | | | | | | | | | | | | |
| | | 3,920 | Lintasan Alam (tampa perkerasan) | | | | | | | | | | | | | | | | | | | | | |
| | | 3,930 | Lintasan dengan struktur semi - permanen | | | | | | | | | | | | | | | | | | | | | |

| LEVEL 3 | | Nilai Kondisi | | | | |
|---------|--------|---------------|---|---|---|----|
| Kode | Elemen | S | R | K | F | NK |



**PEMERINTAH KOTA SEMARANG
DINAS PEKERJAAN UMUM**

JL. MADUKORO RAYA NO. 7, TELP. (024) 76433969, FAX. (024) 76433969 KOTA SEMARANG

NO. JEMBATAN

:

| | | | | | | | | | | | | | | | |
|----|---|---|---|---|---|---|---|---|---|---|---|---|---|---|--|
| KT | 3 | 3 | 0 | 7 | 4 | 1 | 0 | 0 | 1 | 0 | 3 | 0 | 0 | 1 | |
|----|---|---|---|---|---|---|---|---|---|---|---|---|---|---|--|

NAMA JEMBATAN

:

SAPUTAN

POTONGAN MEMANJANG

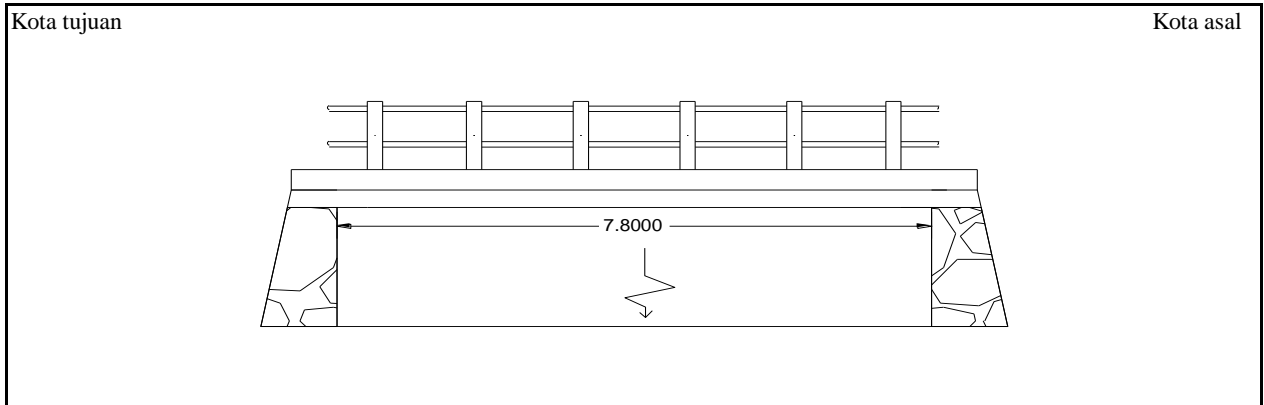

TAMPAK ATAS

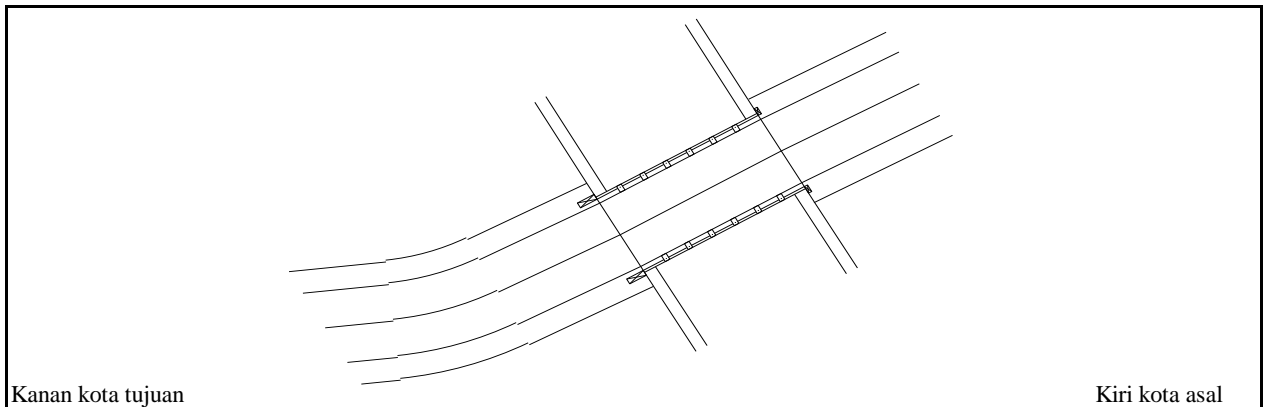

SITUASI

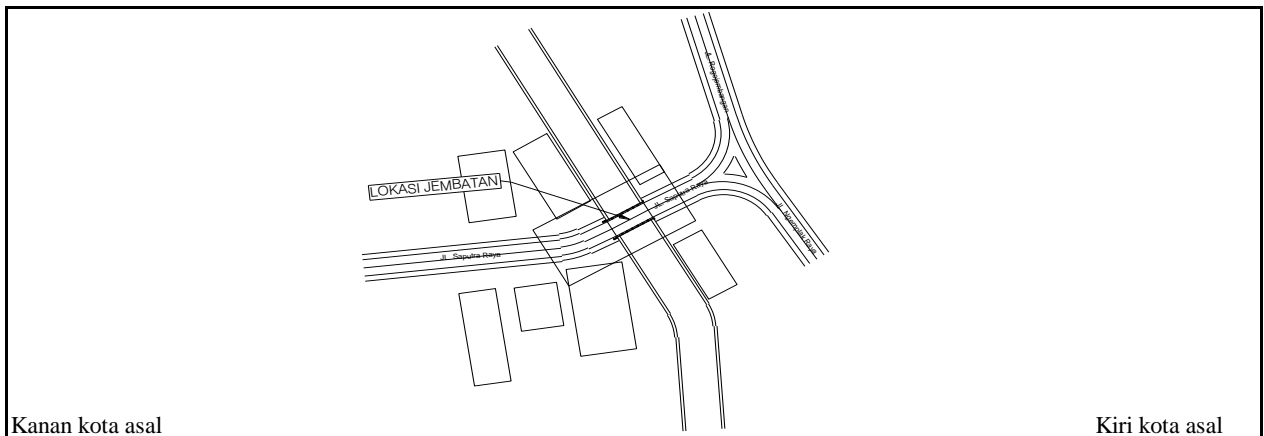



PEMERINTAH KOTA SEMARANG
DINAS PEKERJAAN UMUM

JL. MADUKORO RAYA NO. 7, TELP. (024) 76433969, FAX. (024) 76433969 KOTA SEMARANG

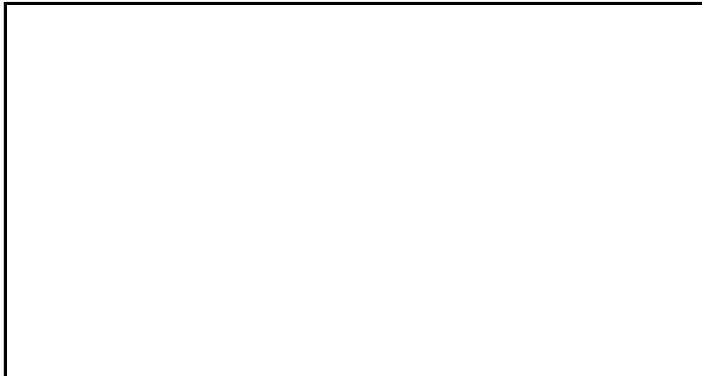
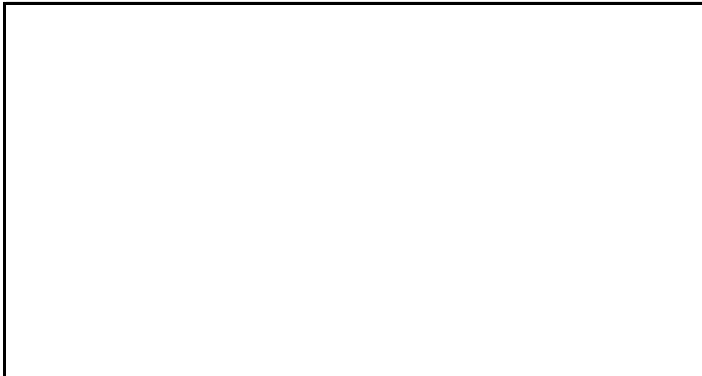
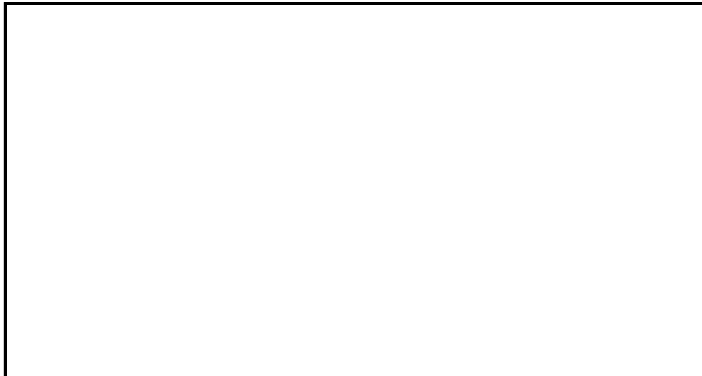
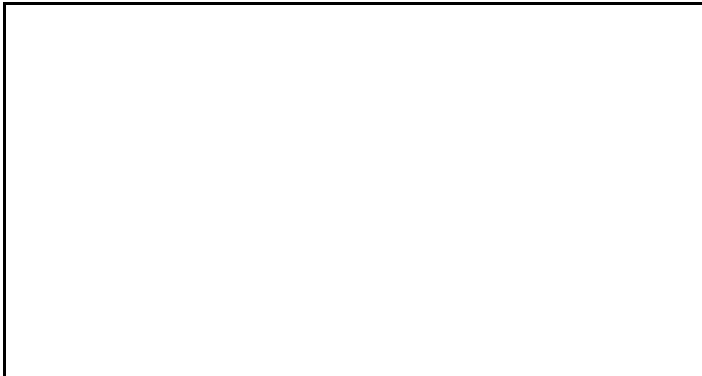
| | |
|---|--|
|  |  |
| TAMPAK MEMANJANG | TAMPAK MEMANJANG |
|  |  |
| TAMPAK MELINTANG | TAMPAK MELINTANG |

| NOMOR JEMBATAN | NAMA JEMBATAN | LOKASI (Km) | PANJANG (M) |
|-----------------------|---------------|---------------|---------------|
| KT.33.074.10.0103.001 | SAPUTAN | 0+020 | 7.80 |



**PEMERINTAH KOTA SEMARANG
DINAS PEKERJAAN UMUM**

JL. MADUKORO RAYA NO. 7, TELP. (024) 76433969, FAX. (024) 76433969 KOTA SEMARANG



KONDISI BANGUNAN BAWAH



SANDRAN KEROPOS DAN PECAH



KONDISI ALRAN SUNGAI



KONDISI LAPISAN PERMUKAAN LANTAI

| NOMOR JEMBATAN | NAMA JEMBATAN | LOKASI (Km) | PANJANG (M) |
|-----------------------|---------------|---------------|---------------|
| KT.33.074.10.0103.001 | SAPUTAN | 0+020 | 7.80 |